

**Series
W70 and W74
Valves and Manifolds
for ANSI Bases**

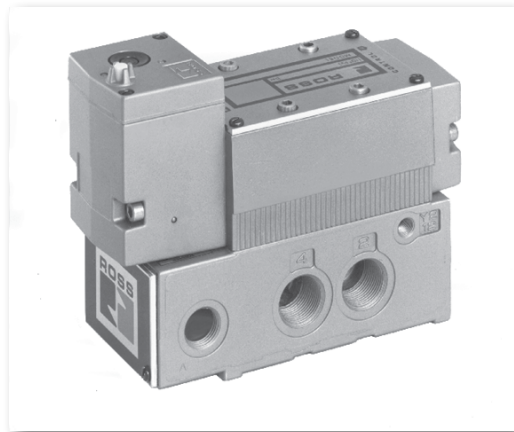

• *Manufacturers of Premium Pneumatic Controls since 1921* •

General Information

Bases conforming to ANSI (American National Standards Institute) are available in nominal sizes 4, 10, and 20 for valves in Series W70 and W74. Bases for size 1.5 and 2.5 valves in these Series are similar in design to the ANSI bases.

All solenoid valves have non-locking flexible-button manual overrides and a 5-pin plug-in electrical connector at the valve-to-base interface. Solenoids are also equipped with indicator lights, with the exception of size 4 valves with direct solenoids, size 1.5 valves with solenoid pilots, and all size 2.5 valves. Bases for size 2.5 valves can be ordered with indicator lights in one end of the base.

Size 1.5 and 2.5 valves have an automatic pilot supply selector. With an external pilot supply line connected to the base, an internal check valve will automatically select the internal or external supply, whichever has the higher pressure. These valves also have available interposed pressure regulators. Electrical power for solenoid valves of all sizes is hard-wired to the base. Neither valve series requires air line lubrication.

SERIES W74 5-port 2-position poppet valves are offered in sizes 1.5, 2.5 and 4. They are used with bases having port sizes ranging from 1/2 to 3/4. Valves have either single control with internal pressure return, or double impulse control. For high-temperature service, models with Viton seals are available.

SERIES W70 5-port 2-position and 3-position valves with precision-finished stainless steel spool-and-sleeve construction are available in nominal sizes 1.5, 2.5, 4, 10, and 20. Bases for these valves have port sizes ranging from 1/4 to 1 1/2. Two-position valves are available with single control and spring return, as well as double impulse control. Three-position valves are offered with either closed-center or open-center design.

ANSI Mounting Options

Sub-bases are available in all sizes and in either side-ported or bottom-ported versions. Signal ports are 1/8. Manifolds are available in all sizes except size 20. All have bottom-ported outlets. In addition, size 1.5, 2.5 and 4 manifolds also have end-ported outlets. Size 4 and size 10 manifolds for pressure controlled valves have signal ports with Legris fittings for 5/32" tubing; other signal ports are threaded 1/8.

Valve Types

Single Control Valves - Single solenoid or pressure control is available for both poppet and spool valves. They are 5-port 2-position (5/2) valves, and they require a maintained signal to keep the valve shifted. Return is by internal pressure for poppet valves, and by spring force for spool valves.

Impulse Controlled Valves with Detent - Double solenoid or pressure control requiring only momentary signals to shift valve in either direction is available for both poppet and spool valves. Detent holds valve in last shifted position. Five-port 2-position (5/2) design.

Closed Center Valves - In the center position of these 5-port 3-position (5/3) valves all ports are closed. Available only in spool construction, but with either double solenoid or double pressure control. Maintained signals required to keep valve shifted from center Position.

Open Center Valves - In the center position of these 5-port 3-position (5/3) valves the outlet ports are connected to the exhaust ports and the inlet port is closed. Available only in spool construction, but with either double solenoid or double pressure control. Maintained signals required to keep valve shifted from center position.

Poppet Construction - Rugged and Economical

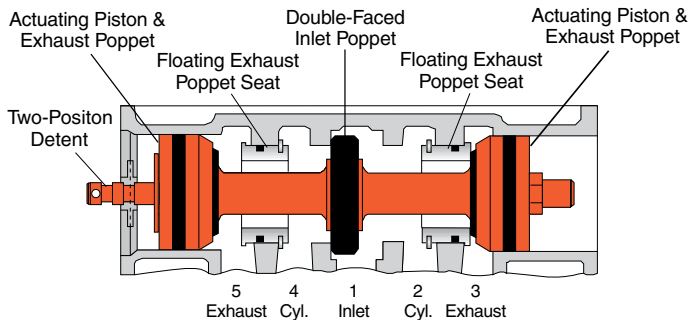

Double-Control Model Illustrated

Metal internals (except seals) provide the ruggedness to cope with wide-ranging operating conditions. Floating exhaust poppet seats are self-adjusting to equalize wear and promote long life. After a shutdown, valve is ready to go because it doesn't build up breakaway resistance due to dirt and varnish. Use in systems with or without air line lubrication.

Precision Finished Stainless Steel Spool and Sleeve Construction

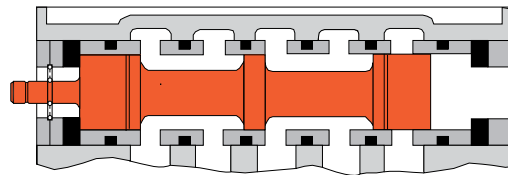

Double-Control Model Illustrated

Matched spool and sleeve are precision finished, hardened, stainless steel. Spool moves on a micro-inch film of air between spool and sleeve. Use in systems with or without air line lubrication. This design is noted for its long life and reliability in high speed and/or high-cycle operations. Balanced design is useful in selector, diverter, or dual pressure service.

Series W70 Spool & Sleeve Valves for ANSI Bases

5/2 Valves – Single Direct Solenoid, Spring Return

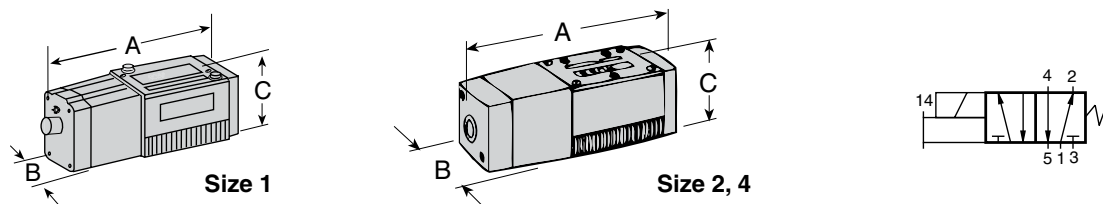

ANSI Size	Range of Port Sizes	Valve Model Number*	Avg. C_v	Dimensions inches (mm)			Weight lb (kg)
				A	B	C	
1	1/4 - 3/8	W7016A2331	1.0	7.0 (177)	2.0 (50)	2.3 (58)	3.5 (1.6)
2.5	3/8 - 1/2	W7016A3331	2.5	8.3 (209)	2.6 (66)	2.6 (66)	3.3 (1.5)
4	3/8 - 3/4	W7016C4331	4.2	10.0 (254)	3.5 (88)	2.8 (70)	4.3 (1.9)

* Base not included. See pages 8-10 for accessories.

5/2 Valves – Double Direct Solenoid, Detented

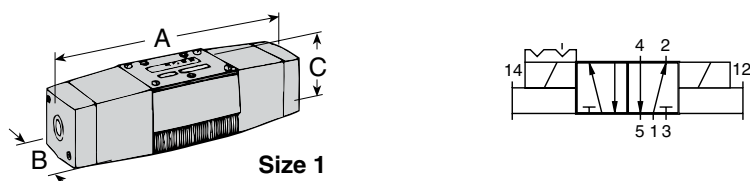

ANSI Size	Range of Port Sizes	Valve Model Number*	Avg. C_v	Dimensions inches (mm)			Weight lb (kg)
				A	B	C	
1	1/4 - 3/8	W7016A2332	1.0	8.9 (226)	2.0 (50)	2.3 (58)	4.5 (2.0)
2.5	3/8 - 1/2	W7016A3332	2.5	10.8 (273)	2.6 (66)	2.6 (66)	5.0 (2.3)
4	3/8 - 3/4	W7016C4332	4.2	13.2 (335)	3.5 (88)	2.8 (70)	5.8 (2.6)

* Base not included. See pages 8-10 for accessories.

5/3 Valves – Double Direct Solenoid

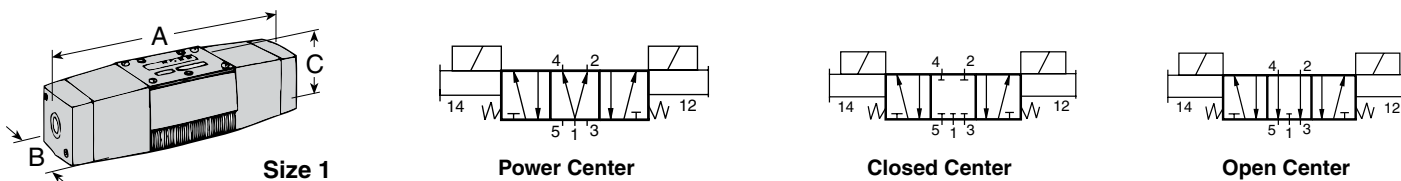

ANSI Size	Range of Port Sizes	Valve Model Number*			Avg. C_v	Dimensions inches (mm)			Weight lb (kg)
		Power Center	Closed Center	Open Center		A	B	C	
1	1/8 - 3/8	W7017A2905	W7017A2331	W7017A2332	1.0	8.9 (226)	2.0 (50)	2.3 (58)	4.5 (2.0)
2.5	3/8 - 1/2	–	W7017A3331	W7017A3332	2.5	10.8 (273)	2.6 (66)	2.6 (66)	5.0 (2.3)
4	1/2 - 3/4	–	W7017C4331	W7017C4332	4.2	13.2 (335)	3.5 (88)	2.8 (70)	5.8 (2.6)

* See pages 8-10 for accessories.

STANDARD SPECIFICATIONS: For valves on this page.

Solenoids: AC power; DC for size 1 models only.

Standard Voltages: See page 110; consult ROSS.

Power Consumption: Each solenoid.

Size 1 models: 140 VA inrush, 30 VA holding on 50 or 60 Hz; 20 watts on DC.

All other sizes: 380 VA inrush, 58 VA holding.

Indicator Light: Available.

Ambient/Media Temperature: 40° to 175°F (4° to 80°C).

Flow Media: Filtered air; 5 micron recommended.

Inlet Pressure: Vacuum to 150 psig (10 bar).

IMPORTANT NOTE

Please read carefully and thoroughly all of the **CAUTIONS** on the inside back cover.



Series W70 Spool & Sleeve Valves for ANSI Bases

5/2 Valves – Single Solenoid Pilot Controlled, Spring Return

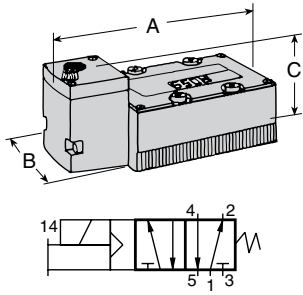

ANSI Size	Range of Port Sizes	Valve Model Number*	Avg. C _v	Dimensions inches (mm)			Weight lb (kg)
				A	B	C	
1	1/4 - 3/8	W7076A2331	1.0	6.4 (163)	2.0 (50)	2.4 (59)	3.0 (1.4)
2.5	3/8 - 1/2	W7076A3331	2.5	7.3 (185)	2.7 (67)	3.6 (91)	3.0 (1.4)
4	3/8 - 3/4	W7076D4331	4.2	8.4 (212)	3.5 (88)	4.0 (101)	5.3 (2.4)
10	3/4 - 1 1/4	W7076C6331	10	9.8 (249)	3.9 (99)	4.0 (101)	7.3 (3.3)
20	1 1/4 - 1 1/2	W7076C8331	22	15 (381)	5.6 (142)	4.1 (104)	14.5 (6.5)

* Base not included. See pages 8-10 for accessories.

5/2 Valves – Double Solenoid Pilot Controlled, Detented

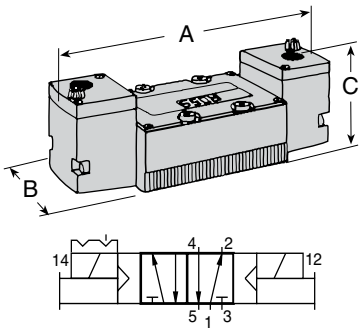

ANSI Size	Range of Port Sizes	Valve Model Number*	Avg. C _v	Dimensions inches (mm)			Weight lb (kg)
				A	B	C	
1	1/4 - 3/8	W7076A2332	1.0	7.7 (194)	2.0 (50)	2.4 (59)	4.0 (1.8)
2.5	3/8 - 1/2	W7076A3332	2.5	8.8 (224)	2.7 (67)	3.6 (91)	4.0 (1.8)
4	3/8 - 3/4	W7076D4332	4.2	9.8 (249)	3.5 (88)	4.0 (101)	6.5 (2.9)
10	3/4 - 1 1/4	W7076C6332	10	11.3 (286)	3.9 (99)	4.0 (101)	9.0 (4.1)
20	1 1/4 - 1 1/2	W7076C8332	22	16.5 (417)	5.6 (142)	4.1 (104)	15.8 (6.8)

* Base not included. See pages 8-10 for accessories.

5/3 Valves – Double Solenoid Pilot Controlled

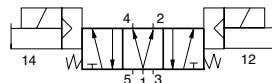
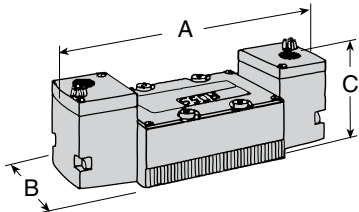

Power Center

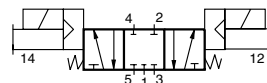

Closed Center

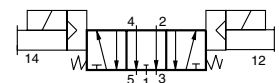

Open Center

ANSI Size	Range of Port Sizes	Valve Model Number*			Avg. C _v	Dimensions inches (mm)			Weight lb (kg)
		Power Center	Closed Center	Open Center		A	B	C	
1	1/4 - 3/8	W7077A2906	W7077A2331	W7077A2332	1.0	7.7 (194)	2.0 (50)	2.4 (59)	4.0 (1.8)
2.5	3/8 - 1/2	W7077A3904	W7077A3331	W7077A3332	2.5	8.8 (224)	2.7 (67)	3.6 (91)	4.0 (1.8)
4	3/8 - 3/4	W7077C4939	W7077D4331	W7077D4332	4.2	9.8 (249)	3.5 (88)	4.0 (101)	6.5 (2.9)
10	3/4 - 1 1/4	W7077A6920	W7077C6331	W7077C6332	10	12.1 (307)	3.9 (99)	4.0 (101)	8.5 (3.8)
20	1 1/4 - 1 1/2	W7077A8901	W7077C8331	W7077C8332	22	16.5 (417)	5.6 (142)	4.1 (104)	15.3 (6.9)

* See pages 8-10 for accessories.

STANDARD SPECIFICATIONS: For valves on this page.

Solenoids: AC or DC power.

Standard Voltages: See page 110; consult ROSS.

Power Consumption: Each solenoid.

Size 1 models: 10 VA inrush, 9 VA holding on 50 or 60 Hz; 5 watts on DC.

All other sizes: 87 VA inrush, 30 VA holding on 50 or 60 Hz; 14 watts on DC.

Indicator Light: Size 4, 10 & 20 models only.

Ambient Temperature: 40°F to 120°F (4°C to 50°C).

Media Temperature: 40° to 175°F (4° to 80°C).

Flow Media: Filtered air; 5 micron recommended.

Inlet Pressure: Vacuum to 150 psig (10 bar).

Pilot Pressure:

Size 1 & 20 models: At least 30 psig (2 bar).

Size 2.5, 4 & 10 models: At least 15 psig (1 bar).

IMPORTANT NOTE: Please read carefully and thoroughly all of the **CAUTIONS** on the inside back cover.

Series W70 Spool & Sleeve Valves for ANSI Bases

5/2 Valves – Single Pressure Controlled, Spring Return

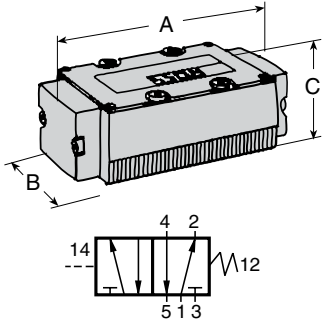

ANSI Size	Range of Port Sizes	Valve Model Number*	Avg. C _v	Dimensions inches (mm)			Weight lb (kg)
				A	B	C	
1	1/4 - 3/8	W7056A2331	1.0	5.1 (128)	2.0 (50)	2.3 (58)	2.5 (1.1)
2.5	3/8 - 1/2	W7056A3331	2.5	5.7 (145)	2.6 (66)	2.6 (66)	2.0 (0.9)
4	3/8 - 3/4	W7056B4331	4.2	6.9 (174)	3.5 (88)	2.8 (70)	4.3 (1.9)
10	3/4 - 1¼	W7056A6331	10	8.3 (211)	3.9 (99)	2.7 (68)	6.3 (2.8)
20	1¼ - 1½	W7056A8331	22	13.5 (342)	5.6 (142)	3.0 (76)	13.0 (5.9)

* Base not included. See pages 8-10 for accessories.

5/2 Valves – Double Pressure Controlled, Detented

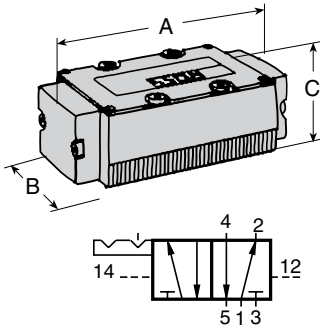

ANSI Size	Range of Port Sizes	Valve Model Number*	Avg. C _v	Dimensions inches (mm)			Weight lb (kg)
				A	B	C	
1	1/4 - 3/8	W7056A2332	1.0	5.1 (128)	2.0 (50)	2.3 (58)	2.5 (1.1)
2.5	3/8 - 1/2	W7056A3332	2.5	5.7 (145)	2.6 (66)	2.6 (66)	2.0 (0.9)
4	3/8 - 3/4	W7056B4332	4.2	6.9 (174)	3.5 (88)	2.8 (70)	4.3 (1.9)
10	3/4 - 1¼	W7056A6332	10	8.3 (211)	3.9 (99)	2.7 (68)	6.3 (2.8)
20	1¼ - 1½	W7056A8332	22	13.5 (342)	5.6 (142)	3.0 (76)	13.8 (6.2)

* Base not included. See pages 8-10 for accessories.

5/3 Valves – Double Pressure Controlled

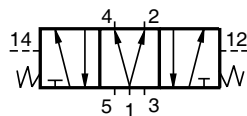
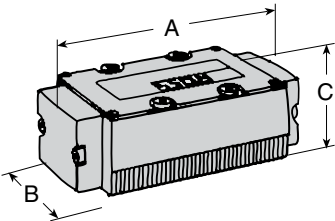

Power Center

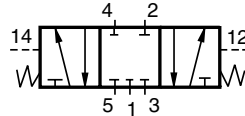

Closed Center

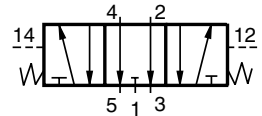

Open Center

ANSI Size	Range of Port Sizes	Power Center	Valve Model Number*		Avg. C _v	Dimensions inches (mm)			Weight lb (kg)
			Closed Center	Open Center		A	B	C	
1	1/8 - 3/8	–	W7057A2331	W7057A2332	1.0	5.1 (128)	2.0 (50)	2.3 (58)	2.5 (1.1)
2.5	3/8 - 1/2	–	W7057A3331	W7057A3332	2.5	5.7 (145)	2.6 (66)	2.6 (66)	2.0 (0.9)
4	1/2 - 3/4	–	W7057B4331	W7057B4332	4.2	6.9 (174)	3.5 (88)	2.8 (70)	4.5 (2.0)
10	3/4 - 1¼	W7057A6902	W7057A6331	W7057A6332	10	8.3 (211)	3.9 (99)	2.7 (68)	6.3 (2.8)
20	1¼ - 1½	–	W7057A8331	W7057A8332	22	13.5 (342)	5.6 (142)	3.0 (76)	13.8 (6.2)

* Base not included. See pages 8-10 for accessories.

STANDARD SPECIFICATIONS: For valves on this page.

Ambient Temperature: 40° to 175°F (4° to 80°C).

Flow Media: Filtered air; 5 micron recommended.

Inlet Pressure: Vacuum to 150 psig (10 bar).

Pilot Pressure:

Size 1 & 20 models: At least 30 psig (2 bar).

Size 2.5, 4 & 10 models: At least 15 psig (1 bar).

IMPORTANT NOTE: Please read carefully and thoroughly all of the **CAUTIONS** on the inside back cover.



Series W74 Poppet Valves for ANSI Bases

5/2 Valves – Single Solenoid Pilot Controlled, Air Return

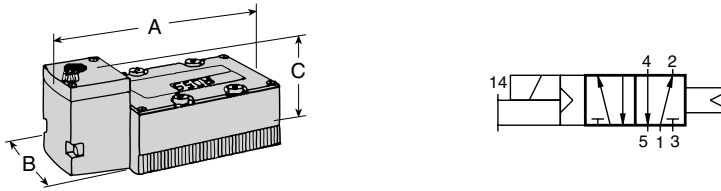

ANSI Size	Range of Port Sizes	Valve Model Number*		Avg. C_v	Dimensions inches (mm)			Weight lb (kg)
		Std. Temp.	High Temp.		A	B	C	
1	1/4 - 3/8	W7476A2331	W7476A2336	0.9	6.5 (164)	2.0 (50)	2.4 (59)	3.0 (1.4)
2.5	3/8 - 1/2	W7476A3331	W7476A3336	2.0	7.3 (185)	2.7 (67)	3.6 (91)	3.0 (1.4)
4	3/8 - 3/4	W7476C4331	W7476B4336	4.2	8.4 (212)	3.5 (88)	4.0 (101)	5.0 (2.3)
10	3/4 - 1¼	W7476A6331	W7476A6336	11	9.8 (249)	3.9 (99)	4.0 (101)	6.1 (2.8)
20	1¼ - 1½	W7476A8331	W7476A8336	22	15.0 (381)	5.6 (142)	4.1 (104)	18.5 (8.3)

* Base not included. See pages 8-10 for accessories.

5/2 Valves – Double Solenoid Pilot Controlled, Detented

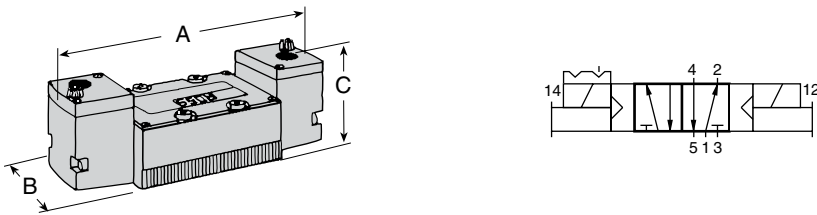

ANSI Size	Range of Port Sizes	Valve Model Number*		Avg. C_v	Dimensions inches (mm)			Weight lb (kg)
		Std. Temp.	High Temp.		A	B	C	
1	1/4 - 3/8	W7476A2332	W7476A2337	0.9	7.7 (194)	2.0 (50)	2.4 (59)	3.5 (1.6)
2.5	3/8 - 1/2	W7476A3332	W7476A3337	2.0	8.8 (224)	2.7 (67)	3.6 (91)	4.0 (1.8)
4	3/8 - 3/4	W7476C4332	W7476C4337	4.2	9.8 (249)	3.5 (88)	4.0 (101)	5.5 (2.5)
10	3/4 - 1¼	W7476A6332	W7476A6337	11	11.3 (286)	3.9 (99)	4.0 (101)	10.8 (4.9)
20	1¼ - 1½	W7476A8332	W7476A8337	22	16.5 (417)	5.6 (142)	4.1 (104)	19.8 (8.9)

* Base not included. See pages 8-10 for accessories.

STANDARD SPECIFICATIONS: For valves on this page.

Solenoids: AC or DC power.

Standard Voltages: See page 110; consult ROSS.

Power Consumption: Each solenoid.

Size 1 models: 10 VA inrush, 9 VA holding on 50 or 60 Hz; 5 watts on DC.

All other sizes: 87 VA inrush, 30 VA holding on 50 or 60 Hz; 14 watts on DC.

Indicator Light: Size 4, 10 & 20 models only.

Ambient Temperature: 40° to 120°F (4° to 50°C); extended to 175°F (80°C) for High Temperature models.

Media Temperature: 40° to 175°F (4° to 80°C); extended to 220°F (105°C) for High Temperature models.

Flow Media: Filtered air; 5 micron recommended.

Inlet Pressure: 30 to 150 psig (2 to 10 bar).

Pilot Pressure: Must be equal to or greater than inlet pressure.

IMPORTANT NOTE: Please read carefully and thoroughly all of the **CAUTIONS** on the inside back cover.

Series W74 Poppet Valves for ANSI Bases

5/2 Valves – Single Pressure Controlled, Air Return

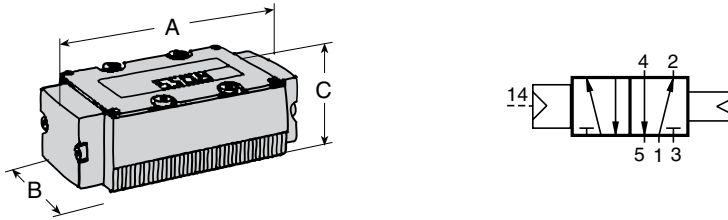

ANSI Size	Range of Port Sizes	Valve Model Number*		Avg. C _v	Dimensions inches (mm)			Weight lb (kg)
		Std. Temp.	High Temp.		A	B	C	
1	1/4 - 3/8	W7456A2331	W7456A2336	0.9	5.1 (128)	2.0 (50)	2.3 (58)	2.5 (1.1)
2.5	3/8 - 1/2	W7456A3331	W7456A3336	2.0	5.7 (145)	2.6 (66)	2.6 (66)	2.0 (0.9)
4	3/8 - 3/4	W7456C4331	W7456C4336	4.2	6.9 (174)	3.5 (88)	2.8 (70)	3.3 (1.5)
10	3/4 - 1¼	W7456A6331	W7456A6336	11	8.3 (211)	3.9 (99)	2.7 (68)	7.3 (3.3)
20	1¼ - 1½	W7456A8331	W7456A8336	22	13.5 (342)	5.6 (142)	3.0 (76)	17.5 (7.9)

* Base not included. See pages 8-10 for accessories.

5/2 Valves – Double Pressure Controlled, Detented

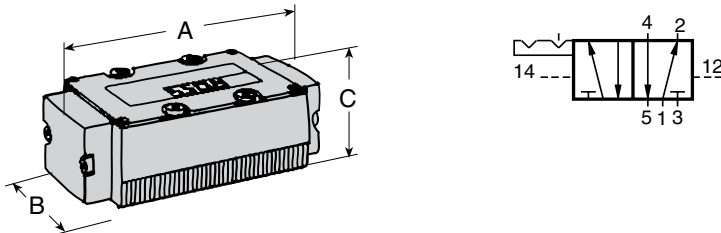

ANSI Size	Range of Port Sizes	Valve Model Number*		Avg. C _v	Dimensions inches (mm)			Weight lb (kg)
		Std. Temp.	High Temp.		A	B	C	
1	1/4 - 3/8	W7456A2332	W7456A2337	0.9	5.1 (128)	2.0 (50)	2.3 (58)	2.5 (1.1)
2.5	3/8 - 1/2	W7456A3332	W7456A3337	2.0	5.7 (145)	2.6 (66)	2.6 (66)	2.0 (0.9)
4	3/8 - 3/4	W7456C4332	W7456C4337	4.2	6.9 (174)	3.5 (88)	2.8 (70)	3.3 (1.5)
10	3/4 - 1¼	W7456A6332	W7456A6337	11	8.3 (211)	3.9 (99)	2.7 (68)	7.3 (3.3)
20	1¼ - 1½	W7456A8332	W7456A8337	22	13.5 (342)	5.6 (142)	3.0 (76)	17.5 (7.9)

* Base not included. See pages 8-10 for accessories.

STANDARD SPECIFICATIONS: For valves on this page.
Ambient/Media Temperature: 40° to 175°F (4° to 80°C); media temperature extended to 220°F (105°C) for High Temperature models.

Flow Media: Filtered air; 5 micron recommended.

Inlet Pressure: 30 to 150 psig (2 to 10 bar).

Pilot Pressure: Must be equal to or greater than inlet pressure.

IMPORTANT NOTE: Please read carefully and thoroughly all of the **CAUTIONS** on the inside back cover.



Sub-Bases for Series W70 & W74 ANSI Valves

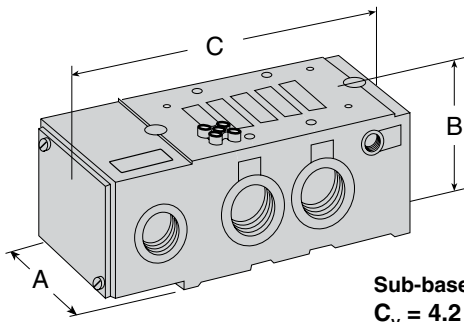

The sub-base numbers shown in the chart below specify pressure ports with NPT threads, and electrical openings with 1/2 NPT threads.

ANSI SUB-BASES

Type of Sub-Base	Outlet Port	Indicator Lights in Base*			Avg. C_v	Dimensions inches (mm)		
		None	One	Two		A	B	C
Side-Ported	1/4	500B91	525K91	526K91	0.9 to 1.0	2.8 (72)	1.6 (41)	6.2 (157)
	3/8	501B91	527K91	528K91	0.9 to 1.0	2.8 (72)	1.6 (41)	6.2 (157)
	3/8	474K91	482K91	484K91	2.0 to 2.5	3.6 (91)	1.5 (37)	7.1 (180)
	1/2	475K91	483K91	485K91	2.0 to 2.5	3.6 (91)	1.5 (37)	7.1 (180)
	3/8	361B91	—	—	4.2	3.3 (84)	2.7 (67)	7.2 (183)
	1/2	362B91	—	—	4.2	3.3 (84)	2.7 (67)	7.2 (183)
	3/4	363B91	—	—	4.2	3.3 (84)	2.7 (67)	7.2 (183)
	3/4	364B91	—	—	10 to 11	5.1 (130)	3.8 (96)	10.5 (266)
	1	365B91	—	—	10 to 11	5.1 (130)	3.8 (96)	10.5 (266)
	1¼	366B91	—	—	10 to 11	5.1 (130)	3.8 (96)	10.5 (266)
	1¼	367B91	—	—	22	6.4 (163)	3.7 (94)	12.4 (314)
	1½	368B91	—	—	22	6.4 (163)	3.7 (94)	12.4 (314)
Side and Bottom-Ported	1/4	499B91	529K91	530K91	0.9 to 1.0	2.8 (72)	1.5 (37)	6.2 (157)
	3/8	476K91	477K91	486K91	2.0 to 2.5	3.6 (91)	1.5 (37)	7.1 (180)
	3/8	369B91	—	—	4.2	3.4 (86)	2.7 (67)	7.2 (183)
	1/2	370B91	—	—	4.2	3.4 (86)	2.7 (67)	7.2 (183)
	3/4	371B91	—	—	4.2	3.4 (86)	2.7 (67)	7.2 (183)
Bottom-Ported	3/4	372B91	—	—	10 to 11	5.1 (130)	3.9 (99)	10.5 (266)
	1	373B91	—	—	10 to 11	5.1 (130)	3.9 (99)	10.5 (266)
	1¼	374B91	—	—	10 to 11	5.1 (130)	3.9 (99)	10.5 (266)
	1¼	375B91	—	—	22	6.4 (163)	3.8 (98)	12.4 (314)
	1½	376B91	—	—	22	6.4 (163)	3.8 (98)	12.4 (314)

*NPT port threads. For BSPP threads, add a "D" prefix to the model number; for JIS threads, add a "J" prefix to the model number.

**Electrical connection conforming to ANSI standard B93.55M is available.
For more information, refer to ROSS Bulletin 379 (form number A10090).**

IMPORTANT NOTE: Please read carefully and thoroughly all of the **CAUTIONS** on the inside back cover.

Manifolds for Series W70 & W74 ANSI Valves

The numbers of the manifold stations shown in the chart below specify pressure ports with NPT threads and electrical openings with 1¼ NPT threads.

All necessary hardware and seals for manifold assembly are included with each manifold station.

Indicator Lights: As shown in the chart below, the smaller sizes of manifolds are available with indicator lights. These lights are located in the end plate covering the electrical cavity.

Manifold Note: The port positions of the solenoid controlled and the pressure controlled manifolds are not the same. For this reason these stations cannot be mixed in the same installation. If both types of valves *must* be used in the same installation, *use only manifold stations for solenoid controlled valves.*

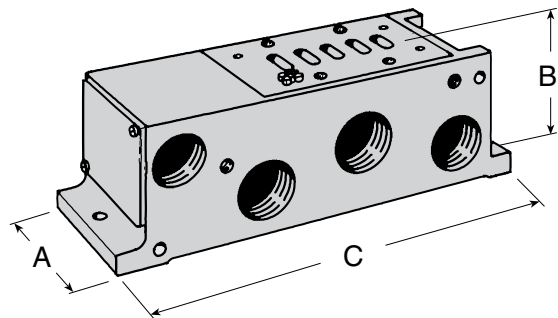

Typical Manifold Station

ANSI MANIFOLDS

Type of Manifold	Outlet Port	Indicator Lights in Manifold*			Avg. C_v	Dimensions inches (mm)		
		None	One**	Two**		A	B	C
For Solenoid Controlled Valves	1/4	502B91	531K91	532K91	0.9 to 1.0	2.3 (57)	2.3 (58)	8.0 (205)
	3/8	503B91	533K91	534K91	0.9 to 1.0	2.3 (57)	2.3 (58)	8.0 (205)
	3/8	472K91	478K91	480K91	2.0 to 2.5	2.3 (57)	2.3 (57)	8.0 (205)
	1/2	473K91	479K91	481K91	2.0 to 2.5	2.3 (57)	2.3 (57)	8.0 (205)
	3/8	377B91	—	—	4.2	3.54 (90)	3.7 (94)	9.1 (232)
	1/2	378B91	—	—	4.2	3.54 (90)	3.7 (94)	9.1 (232)
	3/4	379B91	—	—	4.2	3.54 (90)	3.7 (94)	9.1 (232)
	3/4	380B91	—	—	10 to 11	4.25 (108)	4.1 (104)	13.3 (338)
	1	381B91	—	—	10 to 11	4.25 (108)	4.1 (104)	13.3 (338)
	1¼	382B91	—	—	10 to 11	4.25 (108)	4.1 (104)	13.3 (338)
For Pressure Controlled Valves	1/4	359B91	—	—	0.9 to 1.0	2.26 (57)	2.3 (58)	6.3 (160)
	3/8	360K91	—	—	0.9 to 1.0	2.26 (57)	2.3 (58)	6.3 (160)
	3/8	468B91	—	—	2.0 to 2.5	2.80 (71)	2.7 (69)	6.9 (174)
	1/2	469B91	—	—	2.0 to 2.5	2.80 (71)	2.7 (69)	6.9 (174)
	3/8	383B91	—	—	4.2	3.54 (90)	3.7 (94)	9.2 (232)
	1/2	384B91	—	—	4.2	3.54 (90)	3.7 (94)	9.2 (232)
	3/4	385B91	—	—	4.2	3.54 (90)	3.7 (94)	9.2 (232)
	3/4	386B91	—	—	10 to 11	4.25 (108)	4.1 (104)	13.3 (338)
	1	387B91	—	—	10 to 11	4.25 (108)	4.1 (104)	13.3 (338)
	1¼	388B91	—	—	10 to 11	4.25 (108)	4.1 (104)	13.3 (338)

*NPT port threads. For BSPP threads, add a "D" prefix to the model number; for JIS threads, add a "J" prefix to the model number.

** Specify voltage on manifold.

Standard Voltages: 24 volts DC; 110 volts AC, 50 Hz; 120 volts AC, 60 Hz; 200 volts AC, 50 Hz; 240 volts AC, 60 Hz. For other voltages, consult ROSS.

ASSEMBLED MANIFOLDS

Valves and manifold stations can be assembled by ROSS to precise specifications.

The assembly is then ready for integration into your system.

For detailed information about such assemblies, consult your ROSS Distributor or call ROSS in the U.S.A. at 1-888-TEK-ROSS (835-7677) or 1-706-356-3708.

IMPORTANT NOTE: Please read carefully and thoroughly all of the **CAUTIONS** on the inside back cover.



Accessories

Interposed Pressure Regulators

Both single and double interposed regulators are available for valves with C_v ratings up to 4.2. A regulator is bolted to the valve's sub-base or manifold station, and the valve is then bolted to the regulator. This mounting method allows the valve to be removed and replaced without disturbing the regulator.

Single pressure regulators provide the same regulated pressure at both outlet ports. Double pressure regulators allow the pressure at each outlet port to be set independently.

A locking type knob is used to set the regulated pressure at any point in the range of:
 5 to 100 psig (0.3 to 7 bar) for size 1 and 2 models;
 5 to 125 psig (0.3 to 8.5 bar) for size = 4.2 models.

Maximum inlet pressure is 150 psig (10 bar).
 Pressure gauge(s) included.

Order regulators by the part numbers shown at the right.

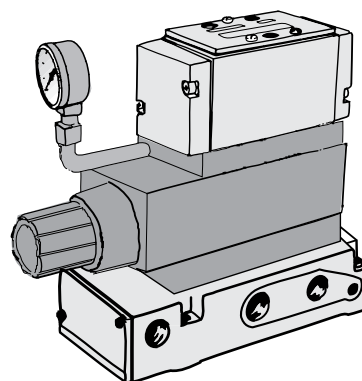

	Single	Double * Solenoid	Single Remote Air
$C_v = 0.9$, Size 1 Valves:	840C91	841C91	713C91
$C_v = 2.0$, Size 2.5 Valves:	626C91	627C91	714C91
$C_v = 4.2$, Size 4 Valves:	632C91	633C91	715C91

* Double regulator only for W70 spool valves.

WARNING
 Double interposed regulators will reverse output ports - the 12 solenoid will pressurize the 4 port, the 14 solenoid will pressurize the 2 port - which may cause unexpected, potentially dangerous cylinder movement at valve pressurization.

Manual Override Kits for Solenoid Pilot Controlled Valves

Flush flexible manual overrides are standard on solenoid pilot controlled valves with C_v ratings of 2.0 or larger. Both locking and non-locking metal override buttons are also available for these models.

Each of the override buttons in the kits at the right is made of metal and is spring-returned. The locking type button, however, can be kept in the actuated position by turning the slot in the top of the button with a screwdriver.

Order by the kit numbers shown at the right.

FLUSH BUTTON

Locking type Kit 792K87
 Non-locking type Kit 790K87

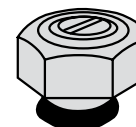

EXTENDED BUTTON

Non-locking type Kit 791K87

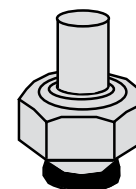

EXTENDED BUTTON WITH PALM ACTUATOR

Non-locking type Kit 984H87

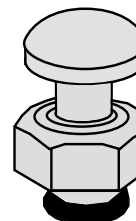

Cautions

PRE-INSTALLATION or SERVICE

1. Before servicing a valve or other pneumatic component, be sure that all sources of energy are turned off, the entire pneumatic system is shut off and exhausted, and all power sources are locked-out (ref: OSHA 1910.147, EN 1037).
2. All ROSS products, including service kits and parts, should be installed and/or serviced only by persons having training and experience with pneumatic equipment. Because any installation can be tampered with or need servicing after installation, persons responsible for the safety of others or the care of equipment must check every installation on a regular basis and perform all necessary maintenance.
3. All applicable instructions should be read and complied with before using any fluid power system in order to prevent harm to persons or equipment. In addition, overhauled or serviced valves must be functionally tested prior to installation and use.
4. Each ROSS product should be used within its specification limits. In addition, use only ROSS parts to repair ROSS products. Failure to follow these directions can adversely affect the performance of the product or result in the potential for human injury.

FILTRATION and LUBRICATION

5. Dirt, scale, moisture, etc. are present in virtually every air system. Although some valves are more tolerant of these contaminants than others, best performance will be realized if a filter is installed to clean the air supply, thus preventing contaminants from interfering with the proper performance of the equipment. ROSS recommends a filter with a 5-micron rating for normal applications.
6. All standard ROSS filters and lubricators with polycarbonate plastic bowls are designed for compressed air applications only. Do *not* fail to use the metal bowl guard, where provided, to minimize danger from high pressure fragmentation in the event of bowl failure. Do not expose these products to certain fluids, such as alcohol or liquefied petroleum gas, as they can cause bowls to rupture, creating a combustible condition, hazardous leakage, and the potential for human injury. Immediately replace a crazed, cracked, or deteriorated bowl. When bowl gets dirty, replace it or wipe it with a clean dry cloth.

7. Only use lubricants which are compatible with materials used in the valves and other components in the system. Normally, compatible lubricants are petroleum base oils with oxidation inhibitors, an aniline point between 180°F (82°C) and 220°F (104°C), and an ISO 32, or lighter, viscosity. Avoid oils with phosphate type additives which can harm polyurethane components, potentially leading to valve failure and/or human injury. If you have questions regarding whether a lubricant used on your system is compatible with ROSS products, please contact ROSS.

AVOID INTAKE/EXHAUST RESTRICTION

8. Do not restrict the air flow in the supply line. To do so could reduce the pressure of the supply air below the minimum requirements for the valve and thereby cause erratic action.
9. Do not restrict a valve's exhaust port as this can adversely affect its operation. Exhaust silencers must be resistant to clogging and have flow capacities at least as great as the exhaust capacities of the valves. Contamination of the silencer can result in reduced flow and increased back pressure.

ROSS expressly disclaims all warranties and responsibility for any unsatisfactory performance or injuries caused by the use of the wrong type, wrong size, or inadequately maintained silencer installed with a ROSS product.

POWER PRESSES

10. Mechanical power presses and other potentially hazardous machinery using a pneumatically controlled clutch and brake mechanism must use a press control double valve with a monitoring device. A double valve without a self-contained monitoring device should be used only in conjunction with a control system which assures monitoring of the valve. All double valve installations involving hazardous applications should incorporate a monitoring system which inhibits further operation of the valve and machine in the event of a failure within the valve mechanism.

ENERGY ISOLATION/EMERGENCY STOP

11. Per specifications and regulations, ROSS **L-O-X**® and manual **L-O-X**® with **EEZ-ON**® operation products are defined as energy isolation devices, NOT AS EMERGENCY STOP DEVICES.

Warranty

Products manufactured by ROSS are warranted to be free of defects in material and workmanship for a period of one year from the date of purchase. ROSS' obligation under this warranty is limited to repair or replacement of the product or refund of the purchase price paid solely at the discretion of ROSS and provided such product is returned to ROSS freight prepaid and upon examination by ROSS such product is found to be defective. This warranty shall be void in the event that product has been subject to misuse, misapplication, improper maintenance, modification or tampering. THE WARRANTY EXPRESSED ABOVE IS IN LIEU OF AND EXCLUSIVE OF ALL OTHER WARRANTIES AND ROSS EXPRESSLY DISCLAIMS ALL OTHER WARRANTIES EITHER EXPRESSED OR IMPLIED WITH RESPECT TO MERCHANTABILITY OR FITNESS FOR A PARTICULAR PURPOSE. ROSS MAKES NO WARRANTY WITH RESPECT TO ITS PRODUCTS MEETING THE PROVISIONS OF ANY GOVERNMENTAL OCCUPATIONAL SAFETY AND/OR HEALTH LAWS OR REGULATIONS. IN NO EVENT SHALL ROSS BE LIABLE TO PURCHASER, USER, THEIR EMPLOYEES OR OTHERS FOR INCIDENTAL OR CONSEQUENTIAL DAMAGES WHICH MAY RESULT FROM A BREACH OF THE WARRANTY DESCRIBED ABOVE OR THE USE OR MISUSE OF THE PRODUCTS. NO STATEMENT OF ANY REPRESENTATIVE OR EMPLOYEE OF ROSS SHALL EXTEND THE LIABILITY OF ROSS AS SET FORTH HEREIN.





GLOBAL Reach with a LOCAL Touchsm

ROSS CONTROLS

Troy, MI., U.S.A.

Telephone: + 1-248-764-1800

Fax: + 1-248-764-1850

In the United States:

Customer Service: 1-800-GET ROSS
(438-7677)

Technical Service: 1-888-TEK-ROSS
(835-7677)

www.rosscontrols.com

ROSS EUROPA GmbH

Langen, Germany

Telephone: + 49-6103-7597-0

Fax: + 49-6103-74694

Email: info@rosseuropa.com

www.rosseuropa.com

ROSS ASIA K.K.

Kanagawa, Japan

Telephone: + 81-427-78-7251

Fax: + 81-427-78-7256

www.rossasia.co.jp

ROSS UK Ltd.

Birmingham, United Kingdom

Telephone: + 44-121-559-4900

Fax: + 44-121-559-5309

Email: sales@rossuk.co.uk

ROSS CONTROLS INDIA Pvt. Ltd.

Chennai, India

Telephone: + 91-44-2624-9040

Fax: + 91-44-2625-8730

Email: rossindia@airtelbroadband.in

ROSS SOUTH AMERICA Ltda.

São Paulo, Brazil CEP 09725-020

Telephone: + 55-11-4335-2200

Fax: + 55-11-4335-3888

Email: vendas@ross-sulamerica.com.br

DIMAFLUID s.a.s.

Saint Ouen, France

Telephone: + 33-01-49-45-65-65

Fax: + 33-01-49-45-65-30

Email: dimafluid@dimafluid.com

www.dimafluid.com

ROSS CONTROLS CHINA Ltd.

Shanghai, China

Telephone: + 86-21-6915-7951

Fax: + 86-21-6915-7960

Email: alvinzhurong@vip.163.com

Your local ROSS distributor is:

There are ROSS Distributors Throughout the World

To meet your requirements across the globe, ROSS distributors are located throughout the world. Through ROSS or its distributors, guidance is available for the selection of ROSS products, both for those using pneumatic components for the first time and those designing complex pneumatic systems.

This catalog presents an overview of the extensive ROSS product line. Other literature is available for engineering, maintenance, and service requirements. If you need products or specifications not shown here, please contact ROSS or your ROSS distributor. They will be happy to assist you in selecting the best product for your application.